

MEET ME AT NOTTING HILL GATE

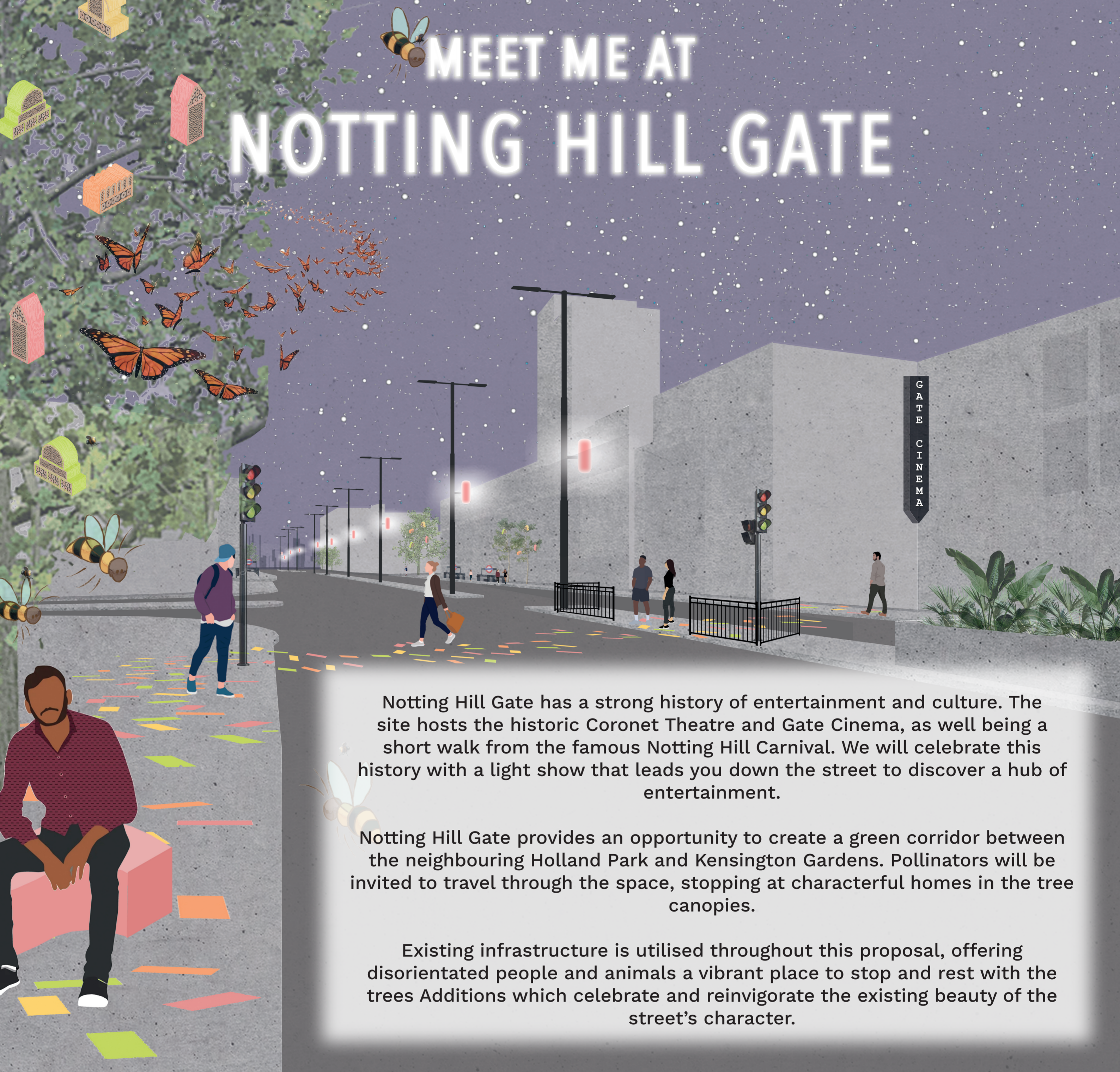

Notting Hill Gate has a strong history of entertainment and culture. The site hosts the historic Coronet Theatre and Gate Cinema, as well being a short walk from the famous Notting Hill Carnival. We will celebrate this history with a light show that leads you down the street to discover a hub of entertainment.

Notting Hill Gate provides an opportunity to create a green corridor between the neighbouring Holland Park and Kensington Gardens. Pollinators will be invited to travel through the space, stopping at characterful homes in the tree canopies.

Existing infrastructure is utilised throughout this proposal, offering disorientated people and animals a vibrant place to stop and rest with the trees. Additions which celebrate and reinvigorate the existing beauty of the street's character.

A place for art, culture and entertainment

A light show leads night time visitors to the historic Coronet Theatre and the Gate Cinema. North and South character areas are connected by confetti super graphics.

Green Corridor



Creating a green route between Holland Park to the West and Hyde Park to the East.

Notting Hill Gate Sites

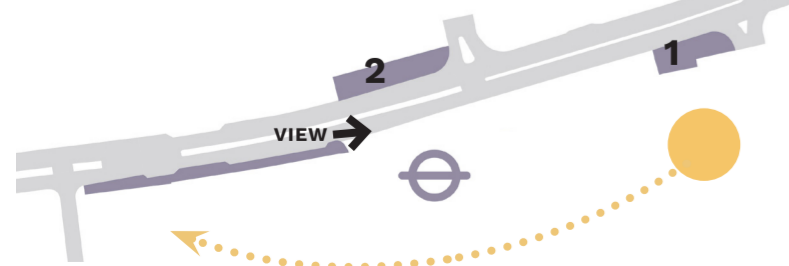

The new Notting Hill Gate. Combining the characters of entertainment and new green infrastructure, rest spots are enhanced on sites with wide pavements.



A lunch spot for local workers

Existing public realm furniture is enhanced to offer a variety of social encounters. Low rise walls and existing benches are utilised to reinvigorate this already beloved space.



A thriving local high street

Supportive of Notting Hill Gate's existing communities, an urban living room is created on a sun drenched, wide pavement. Closely connected to nature, pollinators move through the tree tops.

THE NEW NOTTING HILL GATE

BRANDING GUIDELINE

Typefaces

PHOSPHATE

AVENIR NEXT CONDENSED

ACADEMY ENGRAVED LET

Reminiscent of entertainment culture.

Colour Palette

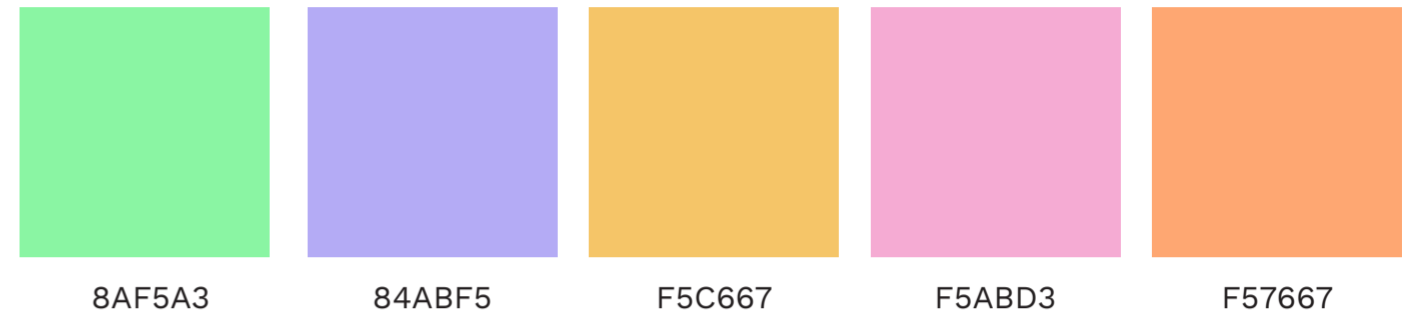

8AF5A3 84ABF5 F5C667 F5ABD3 F57667

A nod to Carnival and attractive to pollinators.

MATERIALS

Seats



Hard wood for seating



Metal brackets to mount

Pollinator Homes



Soft wood for burrowing

Lights

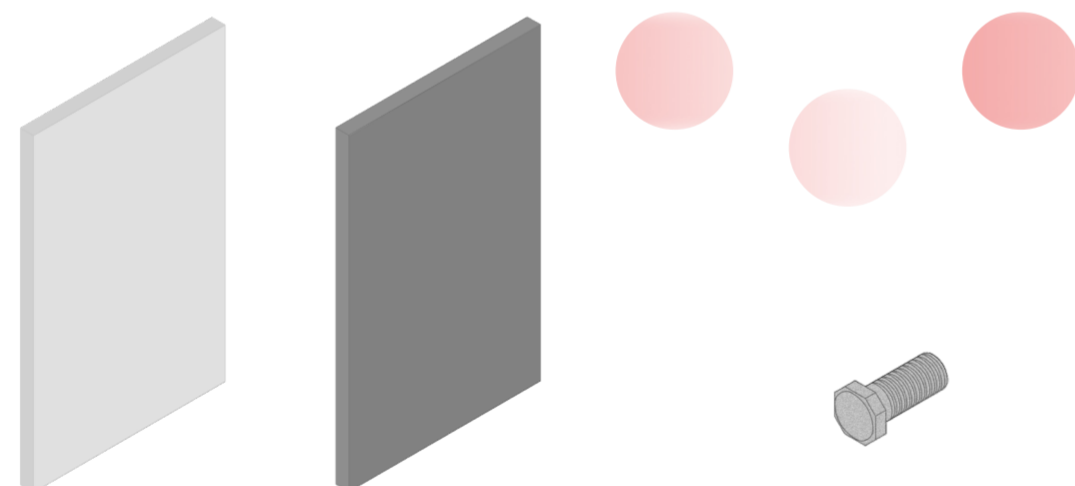

Semi opaque glass, steel plates, LEDs & bolts.

COMPONENTS

Painted Trail



A celebratory confetti trail connects the newly activated spaces and guides visitors down Notting Hill Gate.

Lights



A vibrant show activates the night time economy.

Pollinator Homes

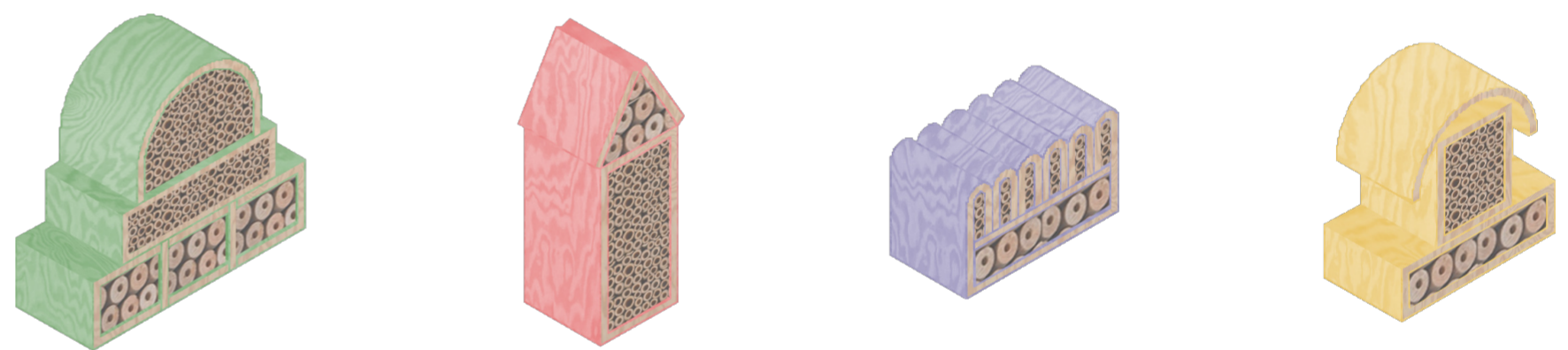

Characterful pollinator homes

Social Benches

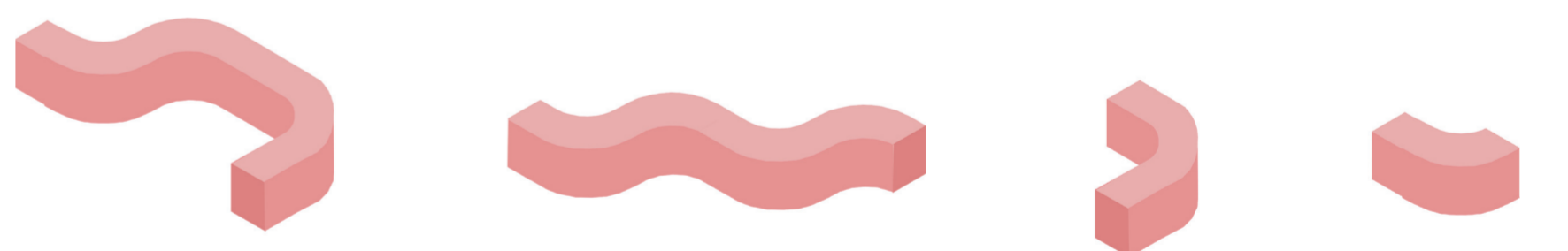

Enhancing currently enjoyed rest spots.

FIXING OPPORTUNITIES FROM EXISTING INFRASTRUCTURE

Tree Canopies



Pollinator homes hung from branches.

Lamp Posts

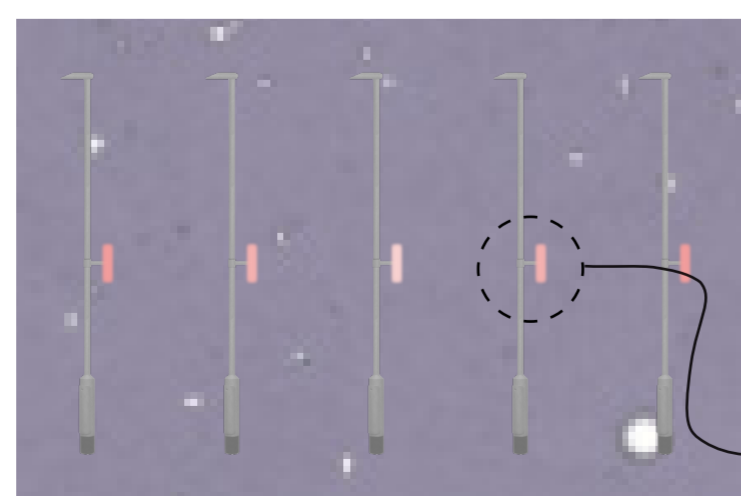

A trail leads visitors from the station to this site of cultural heritage. The narrow site provides no opportunity for rest, but lights add spectacle.

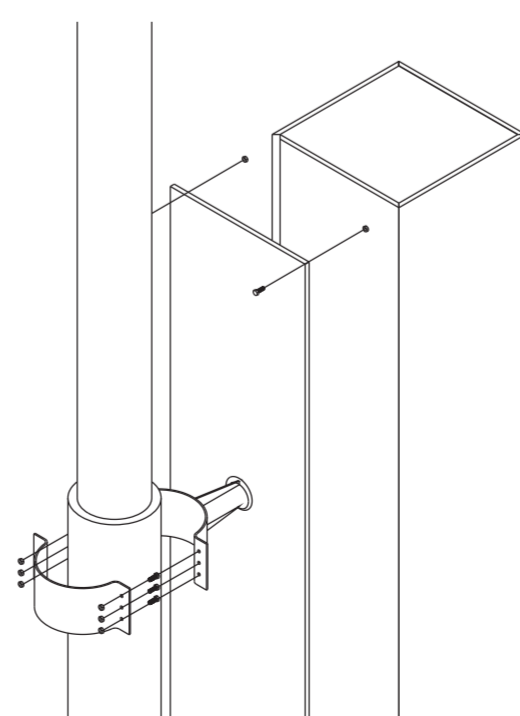

Glass box lights held by steel plate mounted on to lamp post with bracket.

Low Walls / Planters



To attach clip on seating.

Existing Benches



Bridging between existing seating to create varied social settings.